

LONG-TERM TESTING AND MEASUREMENT DATA ANALYSIS OF TOMATO CROP WEIGHT SENSOR MODULE

Andrejs Potapovs¹, Ansis Avotins¹, Juris Gruduls², Rudolfs Ceirs²

¹Riga Technical University, Latvia; ²SIA "Latgales Dārzenū Loģistika", Latvia
andrejs.potapovs@rtu.lv , ansis.avotins@rtu.lv

Abstract. Industrial greenhouses are integrating various Internet of Things (IoT) based sensor technologies to create cloud-based database solutions. Industrial greenhouse control systems are no exception in this regard, as they have recently become more and more popular with the use of various sensors including different types of weight sensors for automation of vegetable and other crop cultivation processes. One of the most important factors hindering the wider implementation of weighting systems in the greenhouse is their high price, where the largest costs are related to the weighing sensors themselves. In addition to the price factor, weight sensor systems on the market are often characterized by known structural and functional limitations, which can be solved if developing a new weighting system. The authors have created and installed IoT based weight sensor modules (TWS) to monitor different weight changes in time, such as irrigation cycle amount or daily tomato yield/weight increase values in real tomato greenhouse of "Latgales darzenu logistika" (further LDL) in Mezvidi parish, with a total growing area of 5062.4 m². This article reveals the test results that are related to measurement stability in 3-year period, measuring the weight parameters 24/7. As a reference, a constant weight was attached to one sensor all the time, and all of them were affected by the industrial greenhouse environment (temperature, humidity, etc). Furthermore, TWS readings were analysed and compared to real greenhouse crop yield data during the growing season (10 months) in weekly periods, allowing to assess potential application of TWS for automatic crop yield evaluation and this data usage for greenhouse control systems or their control algorithm correction issues, with the general aim to raise the level of process automation, quality, energy efficiency, and other important parameters.

Keywords: weight sensor, automation, IoT, industrial greenhouse, tomato crop.

Introduction

As industrial tomato greenhouse main KPI is the produced crop amount that can be sold on market, greenhouse agronomists must have appropriate monitoring tools and control systems in order to achieve the best production results. The main systems to be monitored are indoor/outdoor climate, natural and artificial lighting amount, studies also show that irrigation and mineral nutrients [1] are important factors, and the biomass (incl. fruit weight) growth and tomato plant health, where fluctuating asymmetry could be used [2]. To control the irrigation process of tomatoes, a physical sensor monitoring tomato plants and its soil pod weight [3] can be used. This way it is possible to obtain water (fertilizer) consumption and get precise timing when irrigation must be started and stopped (change in moisture level between start and the end of watering is about 7 to 13%). Weight sensors can be used also to obtain tendency of crop biomass increase and plant overall health according to programmed greenhouse climate values [4; 5]. For irrigation monitoring also cloud-based systems [6] can be used, nevertheless they are not suited for all industrial greenhouse cases, and high precision, but also a high price is hindering wider implementation.

The first studies on market overview and IEEEExplore database show S-type weighting sensors are very popular for industrial greenhouse weighing systems. Metallic S-type tension force sensor readings are affected by temperature changes, therefore a temperature compensation method [7] must be implemented to obtain more accurate measurement data. Interesting sensor mechanism based on Linear Extension Spring [8] and light output measurement enables fast and relatively precise measurements, as the temperature impact seems to be avoided by the implemented design to measure low weight liquids.

The authors assume that the price of a high-quality sensor cost system can be reduced by using considerably cheaper sensor solutions, embedding electronics that will automatically process the readings of this sensor adapting to variations of the ambient temperature, in order to meet the required temperature compensation and the non-linearity of the weight sensor in all possible operating modes [9; 10]. This fact raises a number of scientific research tasks related to the digitization of high-resolution analogue signal of the weight sensors, obtained data filtering post-processing, and subsequently data transmission to the server database.

The goal of this research is to:

1. investigate stability and precision of measurement readings of the developed weight sensor modules in real environment long-term working conditions;
2. analyse obtained tomato crop weight data according to real crop yield data in industrial greenhouse of “Latgales darzenu logistika” Ltd.

Materials and methods

At the moment two types of weight sensor modules (load sensor module (LSM) and a tomato weight sensor (TWS)) are created and tested in industrial greenhouse environment, which are similar to each other in terms of electronic design, but different according to application tasks (see Fig. 1).

LSM₁ and LSM₂ sensors are designed for weighing the base of three tomato plant substrate in order to evaluate the efficiency of the automatic irrigation (water and mineral nutrition) system. One of these modules (LSM₃) is used to test the stability of the obtained weight readings from LSM₁ and LSM₂ sensors, as constant weight is attached to it, enabling comparative long-term data analysis.

TWS sensors, on the other hand, are used to measure the weight of the tomato plant itself, with the ability to track a particular plant at all stages of its growth and to determine its yield, for example, by experimenting with different lighting spectrum combination types and light output levels, lighting periods or by nutrient levels and mineral combinations.

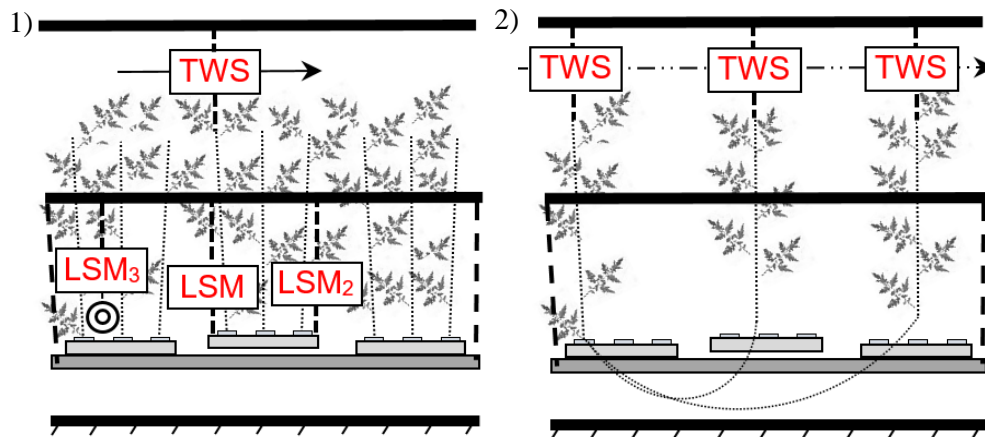

Fig. 1. LSM and TWS testing in real greenhouse environment:
1 – LSM sensors; 2 – TWS sensors

As mentioned, TWS and LSM use the same principal design schematic (see Fig. 2), and the only difference is the maximum working weight value, where LSM uses the S-Type tension force weight sensor (WS) of 50kg maximum load and TWS uses 10kg or 20kg sensor elements in order to avoid overload (saturation) of measured WS values in nominal sensor working range, also corresponding to the potential tomato and crop yield weights during the growing periods. The measured error in laboratory, having high impact of temperatures, reached 3%, after application of corrective algorithm [11], error decreased to 0.1% in average. More detailed description about data aggregation and precision improvements is given in the authors’ previous research papers [11; 12].

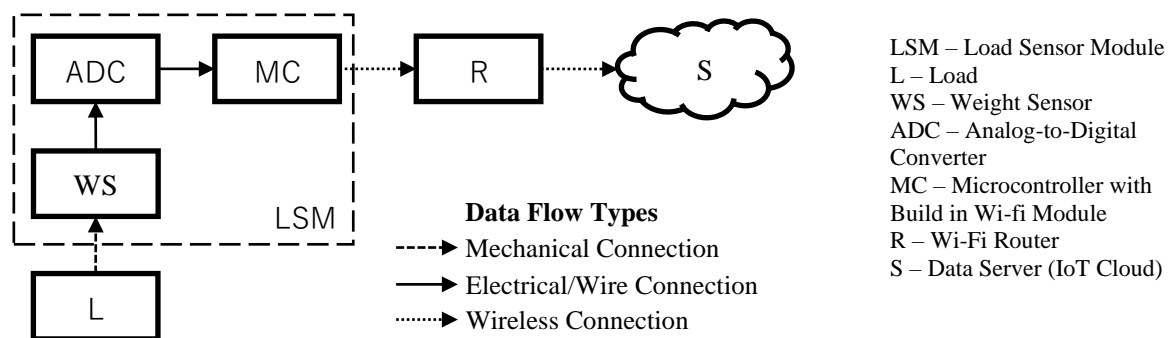

Fig. 2. Block diagram of LSM or TWS for IoT application

MC uses ElectricImp WiFi module (also ESP8266 can be used) together with Teensey 3.2 microcontroller, which makes readings from 24-bit Analogue to Digital Converter. Further digital measurements are transferred to MS-Azure data server database.

The first parameter to be tested is related to the stability of the LSM sensor readings over 11-month period of time, with the aim to test the possibility of effective use of the used WS in one growing season period (typically 10 months) without recalibration. For this reason, LSM sensors were installed in industrial greenhouse of SIA "LDL" in December of 2017, where to sensor module LSM₃ a constant weight of 5200g was attached. Data have been obtained once per minute and sent to the server till this moment. In Fig. 3. we can see the LSM₃ weight readings of one week in December 2017 and January 2021. During the measurements no re-calibration activities were performed, relying only on embedded temperature impact prevention algorithm [11].

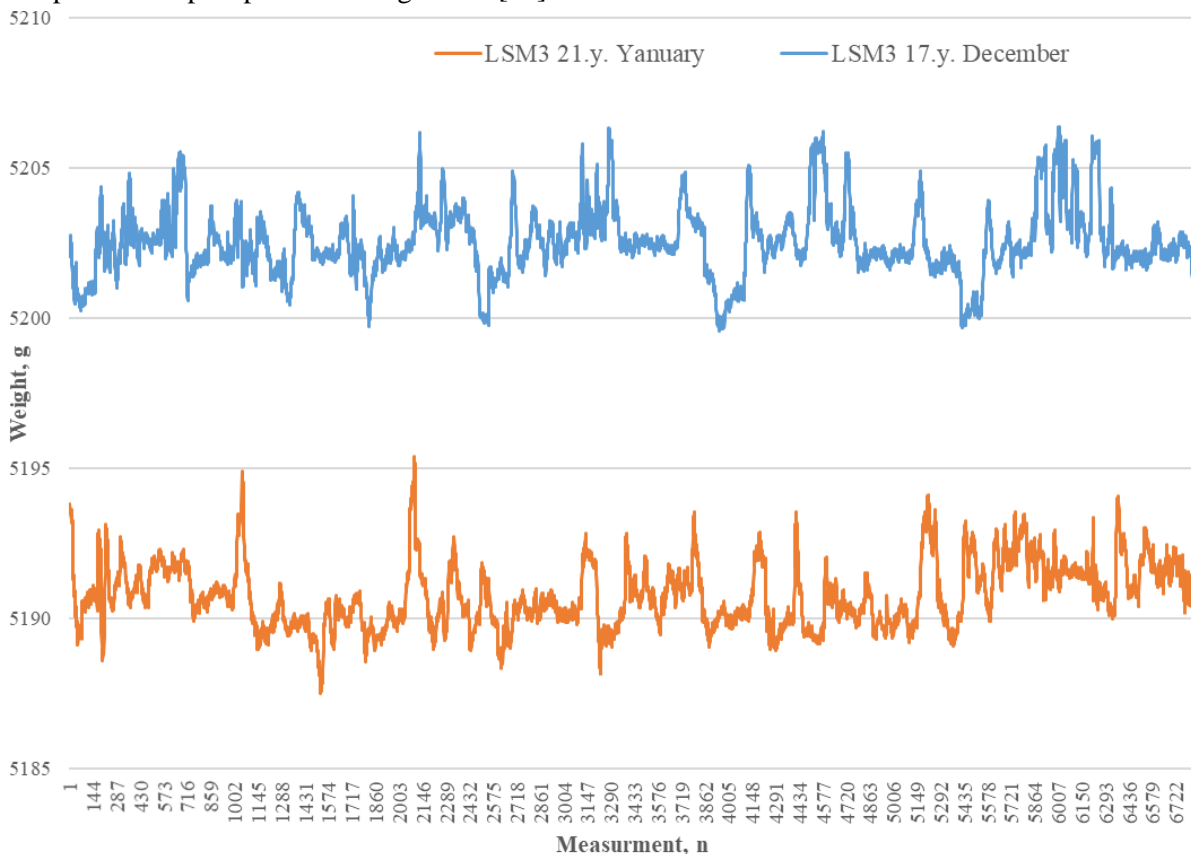

Fig. 3. LSM₃ weight readings of one week in December 2017 and January 2021

In the two graph curves we can observe that difference in the obtained readings is not higher than 0.25% or 15g. After deeper investigation we found out that this shift has occurred between the two seasons (in August 19), when the greenhouse is being rearranged and prepared for the new season, and some physical impact on LSM₃ was possible.

These data allow to conclude that both LSM and TWS sensor modules give high precision long-term measurements, as the initial error is + 0.06% and -0.25% after two years, and therefore should be recalibrated at start of each season to maintain the initial precision.

Further we need to analyse TWS weight readings and compare with the real crop yield data. For this purpose two TWS sensor modules were installed in greenhouse, where external AC/DC 9V power supply was used, and internally 5V voltage stabiliser circuit was implemented to increase stability of MC and ADC circuit power supply voltage, and thus also the precision of TWS measurements (see Fig. 4). 9V AC/DC converter cable was extended from 1m to 7m to keep a possibility to move the sensor along the monitoring tomato plant, which reaches 14m length during season, and do not change the power supply connections of the TWS. Extra 4V voltage difference eliminates cable voltage drop issues at the DC voltage side.

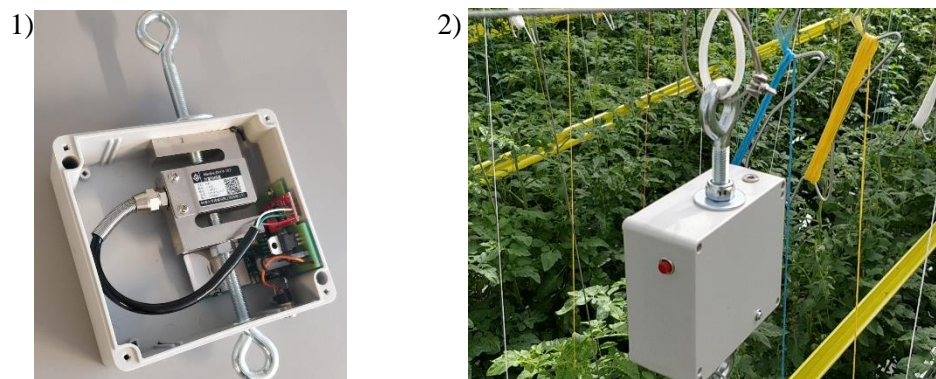

Fig. 4. Installed TWS: 1 – TWS internal layout; 2 – TWS installation in greenhouse

Results and discussion

Two TWS modules (A TWS and H TWS) were installed in real tomato greenhouse of “Latgale darzenu logistika” during the experiment period. Data from these TWS are sent once a minute to a server, from where it can later be retrieved for further analysis. An example of the collected data in the period from 19.10.2019 to 20.01.2020 is shown in Fig. 5.

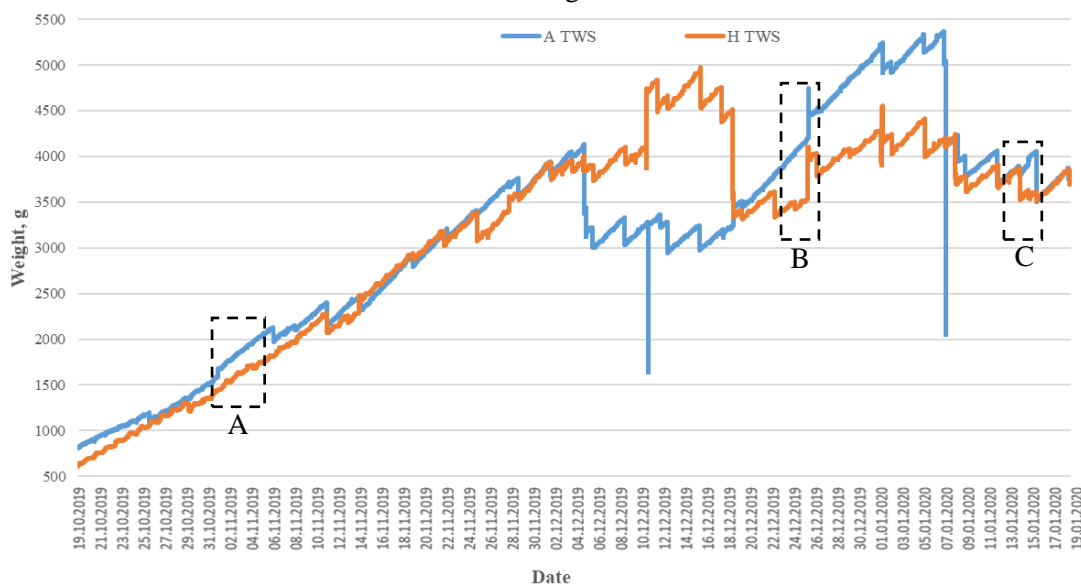

Fig. 5. A TWS and H TWS data from 19.10.2019 to 20.01.2020

After analysing the data of the given graph, we can conclude that with TWS measurement help we can trace such tomato crop weight change scenarios:

- constant and slow increase of the tomato crop (see Fig. 5 field “A”), representing increase of the tomato plant green mass, as well as tomato fruit mass;
- rapid/momentane tomato crop weight value increase, reaching significant change (see field “B”), representing that the tomato plant (or adjacent plants) is bandaged or otherwise physically moved;
- rapid/momentane tomato crop weight value decrease (see field “C”), representing situation, when the crop yield is being harvested (high value changes), old leaves are cut, or tomato plant (or adjacent plants) is re-banded or otherwise physically moved (relatively lower value changes).

In order to determine the weight gain of a tomato plant in a given period of time in an automatic mode using a data processing server, it is necessary to filter the obtained data to discard all weight changes related to tomato green mass and/or fruit removal, re-bandage or other physical movement impact. The filtration is based on the formula (2) below, which is true, if we assume that the change in weight (1) of two consecutive measurements does not exceed the specified maximum difference. In our

case it was determined experimentally and equal to 15 g. As a result, we obtain filtered data as given in Fig. 6.

$$\Delta W = W_i - W_{i-1} < \Delta W_{max} \tag{1}$$

$$W_{fi} = W_{fi-1} + (W_i - W_{i-1}), \tag{2}$$

where W_{fi} – filtered TWS reading;
 W_i – variable two, units.

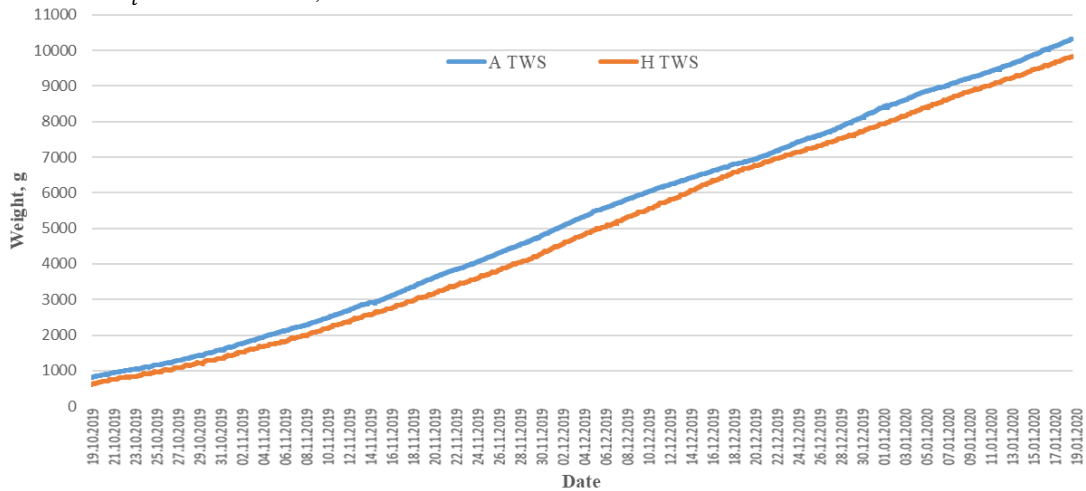

Fig. 6. A TWS and H TWS filtered data from 19.10.2019 to 20.01.2020

From these data, it is possible graphically represent daily TWS measured weight gains (crop yield increase) in grams for “A TWS” (see Fig. 7) and “H TWS” (see Fig. 8) modules.

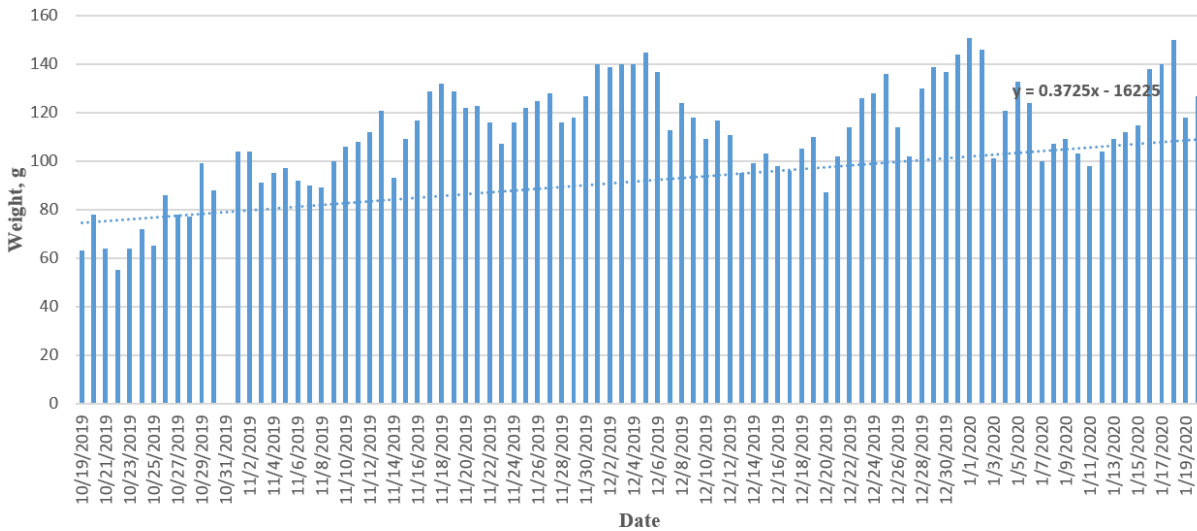

Fig. 7. A TWS weight gain by 24h 19.10.2019 to 20.01.2020

After analysing 134190 readings of the sensor A and H, the daily crop yield gain looks similar (see Fig. 7 and Fig. 8) for both A and H sensors, in case of one-hour the crop increases its weight by 4-7 grams normally. Nevertheless, it is hard to analyse such large data, thus statistical methods of correlation and regression are applied for each sensor data. As we can see, the linear regression function of sensor A data is $\hat{y} = 0.3725x - 16225$ and for sensor H data it is $\hat{y} = 0.4032x - 17574$. Average standard error (S_e) can be calculated by formula (3), in our case it can be treated not as error, but as average standard difference between the values of each different tomato crop.

$$S_e = \sqrt{\frac{\sum_{i=1}^n (y_i - \hat{y}_i)^2}{n-m}} \tag{3}$$

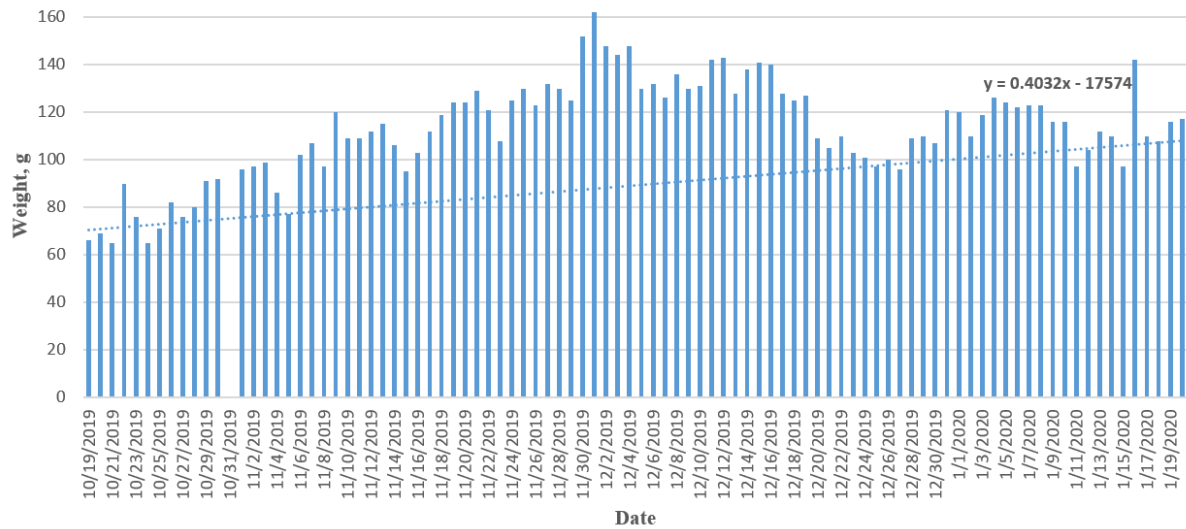

Fig. 8. H TWS weight gain by 24h 19.10.2019 to 20.01.2020

As we can see, the standard deviation value (STDV) is very close for both sensors, showing very low difference (0.69%), which could partly describe the sensor long-term error, median is also very close, showing slight difference of 8.96%. The crop that was attached to the sensor H had lower values of minimum (difference 7.32%) and maximum weight increase (difference 24.72%). S_e values show the difference of 4.36%, and this can be treated as a potential error range, indirectly showing that conditions for the crop attached to the sensor H were more stable than in the sensor A case.

TWS shows trends in total plant weight growth for both tomato fruit and the plant itself (its leaves and stem), but conducting a more detailed analysis, we can conclude that the graph in Fig. 8 represents also real control strategy of crop growth in the whole greenhouse. It is justified by the fact that December had the lowest solar radiation, thus the plant was relieved from inappropriately high doses of nutrients. After such a “respite” period, the plant usually responds with a significant increase in productivity, which is observed in the period from late December to early January. The subsequent decline in productivity (mid-January) is due to the plant’s natural response to increased productivity in the previous period. At the end of January and in the following period, tomato yields are expected to increase due to the natural increase in solar radiation levels.

The conclusions are confirmed by the graph of the actual productivity of Mezvidi LDL greenhouse, which is shown in a weekly section (see Fig. 9) for the same time period as shown in Fig. 7 and Fig. 8.

Table 1

A and H sensor statistical comparison results

Parameter	Sensor A, g	Sensor H, g	difference, %
STDV	1159.55	1151.49	0.69%
Median	3237	3527	-8.96%
min	813	612	24.72%
max	5369	4976	7.32%
S_e	19.74	20.60	-4.36%

Both laboratory and industrial greenhouse experimental measurement results show that LSM weight precision can be increased, if WS working temperature is stable, as dynamic temperature changes have great impact on readings, thus previous or historic WS temperature readings could be used in data post-processing algorithms.

At this stage LSM testing results show their ability to work in industrial greenhouse environment (high humidity, voltage drops, etc), and the obtained data can be used to improve the greenhouse irrigation control systems, and also enable detection of crop biomass growth with high accuracy. Furthermore, the stable precision indicates that such sensors can be implemented in greenhouse control systems as one of the parameters.

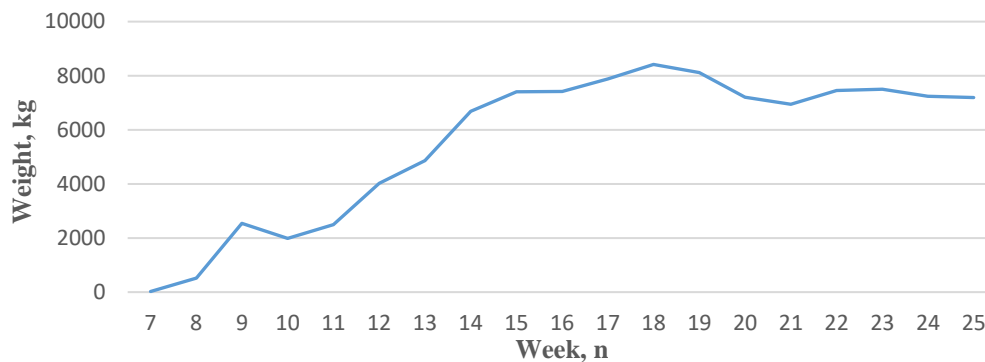

Fig. 9. LDL greenhouse (in Mezvidi) real production kg/week of 2019/2020 season (week 7-25)

Conclusions

Analysing all obtained data (sensor data from the server, as well as additional manually recorded data from the greenhouse) it can be concluded that:

1. The TWS readings at the longer time period show trends in changes in real greenhouse productivity that can already be used to assess the greenhouse efficiency, by analysing together with other greenhouse climate and its management system parameters.
2. The TWS readings of a finer time interval (daily period) can be effectively used after additional processing of TWS data using data post-processing algorithms that were applied to LSM and TWS modules.
3. At the moment, TWS allows to record individual cases of harvesting, recording the mass of the harvested crop with an accuracy of $\pm 10g$.
4. By installing several TWS, the response of individual tomato varieties to the climatic conditions of the greenhouse can be recorded, enabling the possibility to adjust them in separate zones (considering the technical possibilities of the greenhouse climate management system).

Acknowledgements

Publication is created with support of the Latvian Rural Development Program Project No.18-00-A01620-000006 project "Development of greenhouse complex lighting system evaluation method".

References

- [1] Erdal I., Memici M., Dogan A., Yaylaci C., Ekinci K. Effects of tomato harvest residue derived biochars obtained from different pyrolysis temperature and duration on plant growth and nutrient concentrations of corn, *Engineering for Rural Development*, 17, 2018, pp. 547-553.
- [2] Rakutko S., Alsina I., Avotins A., Berzina K. Manifestation of effect of fluctuating asymmetry of bilateral traits of tomato growing in industrial greenhouses. *Engineering for Rural Development*, 2018, 17, pp. 186-191.
- [3] Van Straten G., Van Willigenburg G., Van Helten, E. & Van Ooteghem R. *Optimal Control of Greenhouse Cultivation*. Taylor & Francis Group, 2011. 318 p.
- [4] Ehret D.L., Lau A., Bittman S., Lin W., Shelford T. 2001. Automated monitoring of greenhouse crops. In: INRA, EDP Sciences, 2001. pp. 403-414.
- [5] De Koning A.N.M., Bakker J.C. In situ plant weight measurement of tomato with an electronic force gauge. *Acta Hort.* 304. 1992, pp. 183-186.
- [6] Paskal Launches Cloud-Base Irrigation Monitor Solution [online] [13.03.2021]. Available at: <https://paskal-group.com/page/2/?taxonomy&term=articles>.
- [7] Carrasquilla-Batista A., Chacón-Rodríguez A., Solórzano-Quintana M. "Using IoT resources to enhance the accuracy of overdrain measurements in greenhouse horticulture," 2016 IEEE 36th Central American and Panama Convention (CONCAPAN XXXVI), San Jose, Costa Rica, 2016, pp. 1-5, DOI: 10.1109/CONCAPAN.2016.7942345.
- [8] Roy R. K., Hazarika N., Singh H. K., Bezboruah T. "A Novel Optical Method to Measure Weight by Using Linear Extension Spring," in *IEEE Sensors Letters*, vol. 2, no. 3, pp. 1-4, Sept. 2018, Art no. 3501304, DOI: 10.1109/LESENS.2018.2852499.

-
- [9] Kondratjevs K., Kunicina N., Patlins A., Zabasta A., Galkina A. Vehicle weight detection sensor development for data collecting in sustainable city transport system. In: 57th International Scientific Conference RTUCON, Riga, 2016, pp. 1-5.
- [10] Chen W.T., Yeh Y.H., Liu T.Y., Lin T.T. An Automated and Continuous Plant Weight Measurement System for Plant Factory. *Frontiers in Plant Science* vol 7:392. 2016.
- [11] Avotiņš A., Potapovs A., Apse-Apsītis P., Gruduls J. Crop weight measurement sensor for IoT based industrial greenhouse systems. *BSE2018*, 2018., pp. 1-4.
- [12] Potapovs A., Avotiņš A., Apse-Apsītis P., Gorobecs M., Čeirs P. Continuous Crop Weight Measurement Sensor Calibration Algorithm for Industrial Greenhouse. *IEEE 59th International Scientific Conference on Power and Electrical Engineering of Riga Technical University (RTUCON 2018): Conference Proceedings*, 2018. pp. 1-6.